

# WP- Dynamic

Turbine Water Meter  
for cold water up to 50 °C / PN 16  
DN 40 ... DN 400



## Special Features

---

- Hermetically sealed register (IP 68)
- Patented hydrodynamically balanced rotor ( $\leq$ DN 300)
- Patented symmetrical calibration adjustment ( $\leq$ DN 300)
- Register may be rotated through 360°
- High overload capability
- Pattern approved removable measuring element
- Powder coating affords max. corrosion protection
- Not affected by external magnetic fields

## Application

---

Measurement of high, relatively constant flow rates, e.g. behind pumps

## Options

---

- Up to 3 pulsers (1 x OD, 2 x RD) may be fitted without breaking the approval seal
- 1/4" connection port for pressure sensors
- May be equipped with 3 different electronic registers



HYBRID



ELECTRONIC



ENCODER

Cold water meters pressure rate PN 40 please see special leaflet

UK & Ireland Enquiries  
Sensus Metering Systems  
11 The Quadrangle, Abbey Park,  
Romsey, Hampshire SO51 9DL UK  
T: +44 (0) 1794 526100  
F: +44 (0) 1794 526101  
Email: info.gb@sensus.com

www.sensus.com

International Enquiries  
Sensus Metering Systems GmbH Ludwigshafen  
Industriestrasse 16,  
67063 Ludwigshafen Germany  
T: +49 (0) 621-6904-0  
F: +49 (0) 621-6904-1409  
Email: info.int@sensus.com





www.sensus.com

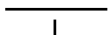

## Pattern Approval Sign

## Installation

<b>D95</b>	Nominal Diameter DN 40 ... DN 300
<b>6.132.36</b>	Marking: Metrological class B 30 °C
<b>D80</b>	Nominal Diameter DN 400
<b>6.132.01</b>	Marking: Metrological class B 30 °C

Pipe	horizontal	
	vertical	
	inclined	
Meter head	upwards	
	sideways	

### Installation Requirements

Unrestricted straight pipe in front of the meter 3 x DN (DN400 5 x DN)

No abrupt restrictions directly behind the meter

## Performance Table

### Performance data WP-Dynamic 50 °C

Nominal Diameter	DN	40	50	65	80	100	125	150	200	250	300	400	
Size of meter (acc. to EEC)	$Q_n$	10	15	25	40	60	100	150	250	400	600	1000	
$Q_{max}$	maximum peak flow												
	once in life time 24 h $Q_{max}$ or 5 min. 1,2 x $Q_{max}$ ( $\pm 2\%$ )	$m^3/h$	60	90	120	200	300	350	600	1200	1600	2000	3000
$Q_n$	continuous flow ( $\pm 2\%$ )	$m^3/h$	40	50	70	120	230	250	450	800	1250	1400	2000
$Q_t$	transitional flow ( $\pm 2\%$ )	$m^3/h$	0.8	0.7	0.8	0.8	1.8	2.0	4.0	6.0	11.0	15.0	50
$Q_{min}$	minimum flow ( $\pm 5\%$ )	$m^3/h$	0.30	0.30	0.40	0.50	0.80	1.00	1.8	4.0	6.0	12.0	25
	starting flow	$m^3/h$	0.15	0.15	0.20	0.25	0.25	0.5	1.0	1.5	3.0	8.0	15

### Performance data according to EEC-specification 30 °C class B

Nominal Diameter	DN	40	50	65	80	100	125	150	200	250	300	400	
Size of meter (acc. to EEC)	$Q_n$	10	15	25	40	60	100	150	250	400	600	1000	
$Q_{max}$	maximum peak flow												
	short time	$m^3/h$	30	30	50	80	120	200	300	500	800	1200	2000
$Q_n$	continuous flow	$m^3/h$	15	15	25	40	60	100	150	250	400	600	1000
$Q_t$	transitional flow	$m^3/h$	3.0	3.0	5.0	8.0	12.0	20.0	30	50	80	120	200
$Q_{min}$	minimum flow	$m^3/h$	0.45	0.45	0.75	1.20	1.80	3.00	4.5	7.5	12.0	18.0	30

## Typical Accuracy Curve

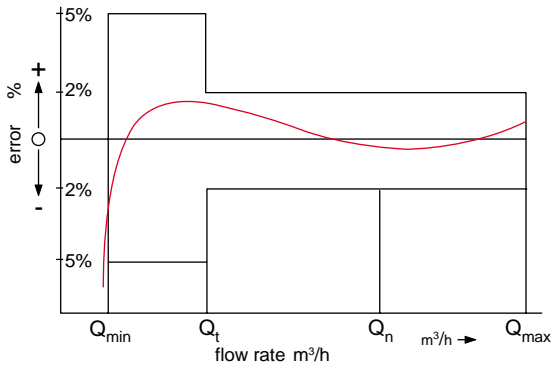

- $Q_{max}$  = maximum peak flow
- $Q_n$  = continuous flow
- $Q_t$  = transitional flow  $\pm 2\%$
- $Q_{min}$  = minimum flow  $\pm 5\%$

## Typical Head Loss Curve

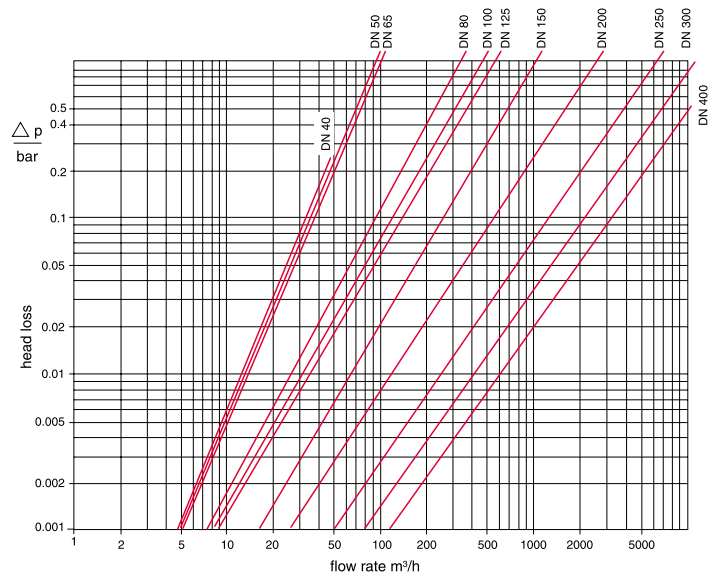

## Dimensions and Weights

Nominal Diameter	DN	40	50	65	80	80	100	125	150	200	250	300	400		
Size of meter (acc. to EEC)	$Q_n$	10	15	25	40	40	60	100	150	250	400	600	1000		
Dimensions	overall length	L *)	mm	220	200	200	200	225	250	250	300	350	450	500	500
	height	H	mm	120	120	120	150	150	150	160	177	206	231	256	380
		h	mm	69	73	85	95	95	105	118	135	162	194	226	295
		g	mm	200	200	200	270	270	270	280	356	441	466	491	785
Weights	meter	kg	7.4	7.7	10.0	13.6	14.0	18.0	20.5	35.5	50.5	72.3	99.3	187	
	measuring element	kg	1.4	1.4	1.4	3.0	3.0	3.0	3.0	5.5	7.5	7.5	7.5	25	
	body	kg	6.0	6.3	8.6	10.6	11.0	15.0	17.5	30.0	43.0	63.8	91.8	162	

\*) Other overall lengths on request

## Dimension Picture

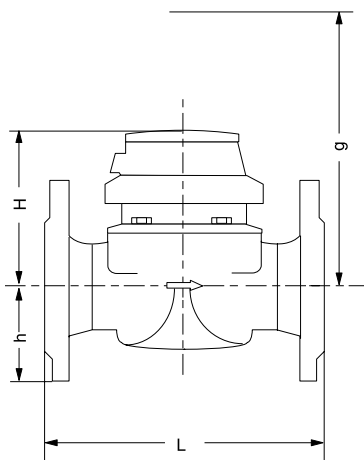

## Materials

Body	PN16	cast iron
Measuring element		plastic
Rotor		plastic
We also use		brass
the following materials		stainless steel

# Dials

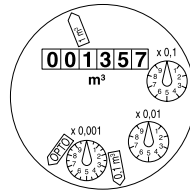

DN 40 ... DN 125

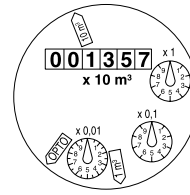

DN 150 ... DN 300

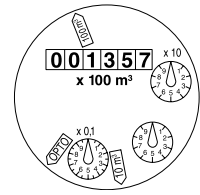

DN 400

Diameter Nominal DN	Smallest reading m <sup>3</sup>	Max. reading m <sup>3</sup>
50 ... 125	0.0005	1 000 000
150 ... 300	0.005	10 000 000
400	0.05	100 000 000

# Pulse Values

Pulser		DN 40 ... DN 125	pulse value DN 150 ... DN 300	DN 400
		RD 01	0.1 and 1 m <sup>3</sup> alternatively 0.01 and 1 m <sup>3</sup>	1 and 10 m <sup>3</sup> alternatively 0.1 and 10 m <sup>3</sup>
OD 01		0.001 m <sup>3</sup>	0.01 m <sup>3</sup>	0.1 m <sup>3</sup>
OD 03		0.01 m <sup>3</sup>	0.1 m <sup>3</sup>	1 m <sup>3</sup>